

Информационен лист | Номер на артикул: 788-508

Relay module; Nominal input voltage: 230 VAC; 1 changeover contact;  
Limiting continuous current: 16 A; Red status indicator; Module width: 15 mm; 2,50 mm<sup>2</sup>; gray

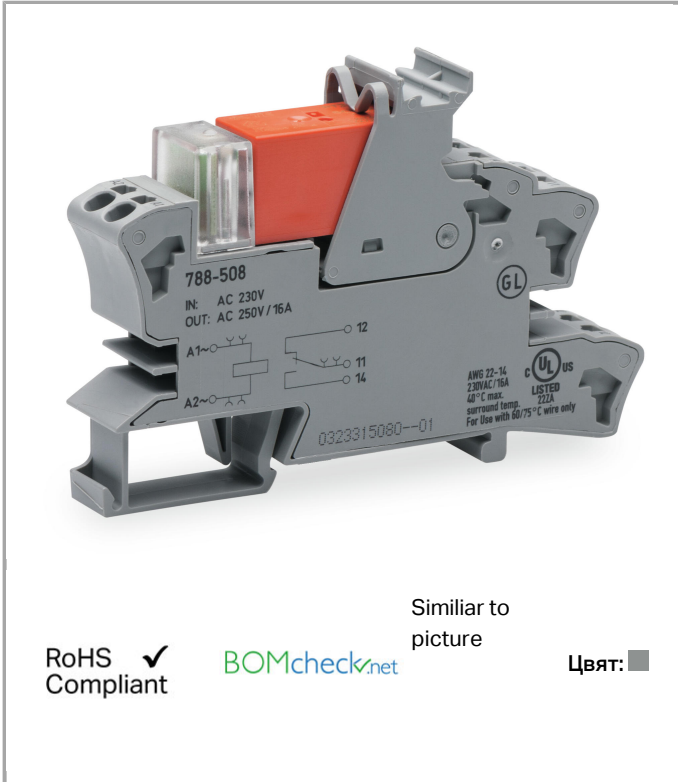

[www.wago.com/788-508](http://www.wago.com/788-508)



Similar to picture

RoHS Compliant ✓

BOMcheck.net

Цвят: ■

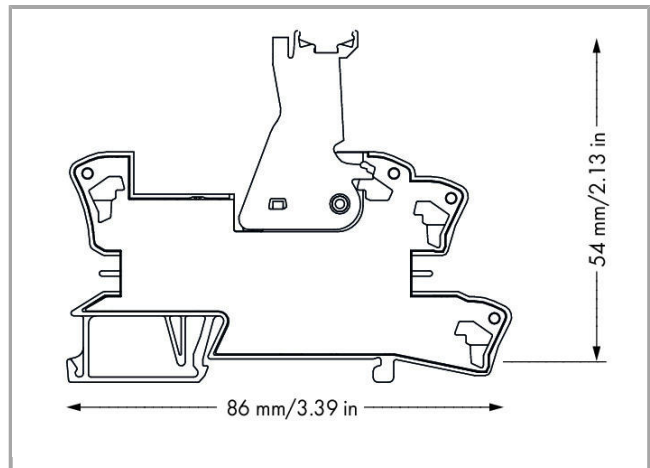
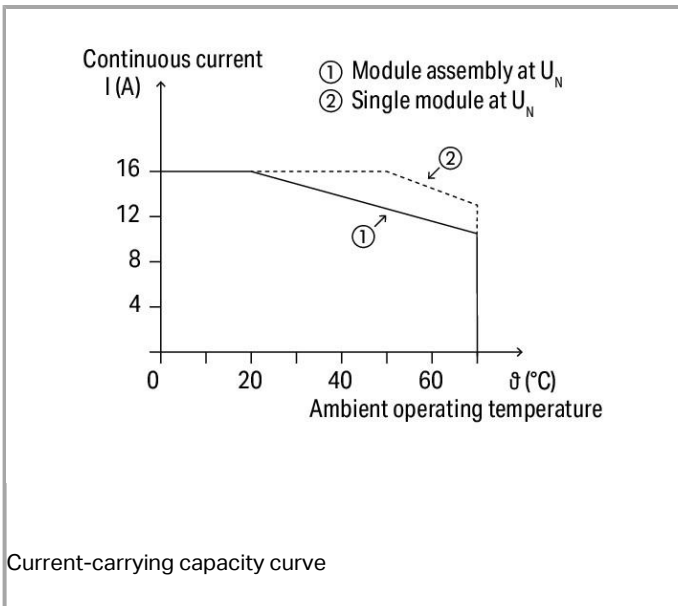
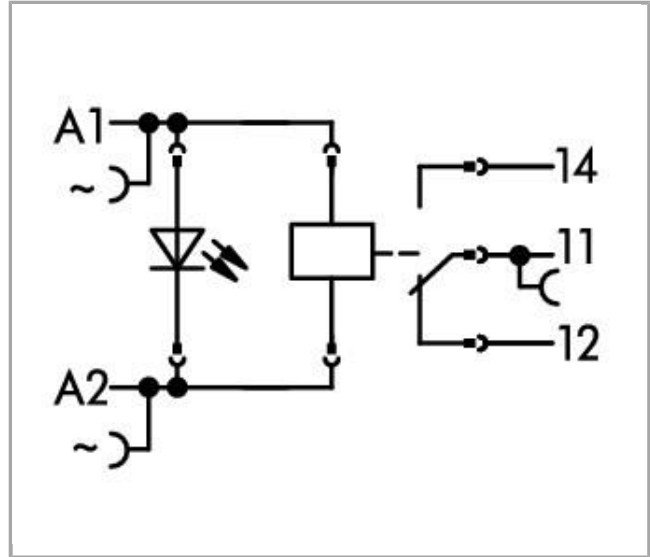

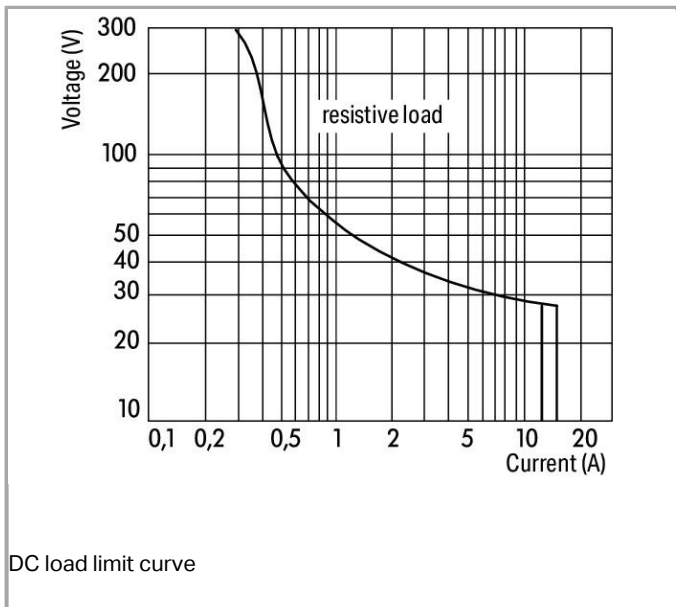

## Описание на артикула

### Note:

- Reinforced insulation between coil and contacts
- A separator plate (e.g., 209-191) must be used for voltages greater than 250 V between adjacent relay modules and for compliance with the reinforced insulation requirements.
- To protect the relay coils and contacts, inductive loads must be dampened with an effective protection circuit.

## Данни

### Technical Data

#### Control circuit

Nominal input voltage $U_N$	AC 230 V
Input voltage range	$\pm 10\%$
Nominal input current at $U_N$	3.5 mA

#### Load circuit:

Number of changeover/switchover contacts	1
Contact material (relay)	AgNi 90/10
Limiting continuous current	16 A
Max. make current (resistive)	(AC) 30 A / 4 s
Max. switching voltage	AC 250 V
Max. switching power (resistive)	AC 4000 VA; DC see load limit curve
Switching capacity	AC-15: 6 A / AC 250 V; DC-13: 2 A / DC 24 V



Recommended minimum load	12 V / 10 mA
Pull-in time (typ.)	10 ms
Drop-out time (typ.)	35 ms
Bounce time (typ.)	6 ms
Electrical life (N.O.; resistive load; 23 °C)	30 x 10 <sup>3</sup> switching operations
Mechanical life	5 x 10 <sup>6</sup> switching operations
Max. switching load with load/without load	6 min <sup>-1</sup> / 600 min <sup>-1</sup>

### Signaling

Status indication	LED red
-------------------	---------

### Safety and protection:

Rated voltage	250 V
Rated impulse voltage	4 kV
Pollution degree	3
Dielectric strength, control/load circuit (AC, 1 min)	5 kVrms
Dielectric strength open contact (AC, 1 min)	1 kVrms
Protection class	IP20

### Connection data

Connection technology	Push-in CAGE CLAMP®
Solid conductor	0.34 ... 2.5 mm <sup>2</sup> / 22 ... 14 AWG
Fine-stranded conductor	0.34 ... 2.5 mm <sup>2</sup> / 22 ... 14 AWG
Strip length	9 ... 10 mm / 0.35 ... 0.39 inch

### Geometrical Data

Width	15 mm / 0.591 inch
Height from upper-edge of DIN-35 rail	54 mm / 2.126 inch
Depth	86 mm / 3.386 inch

### Mechanical data

Type of mounting	DIN-35 rail
------------------	-------------

### Material Data

Color	gray
Fire load	0.863 MJ
Weight	45.72 g

## Environmental Requirements

Pollution degree	3
Surrounding air (operating) temperature at U <sub>N</sub>	-40 ... 70 °C
Surrounding air (storage) temperature	-40 ... 70 °C
Processing temperature	-25 ... +50 °C
Surrounding air (operating) temperature for UL	-25 ... 40 °C

## Standards and specifications

Standards/specifications	EN 61010-2-201; EN 61810-1; EN 61373; GL; UL 508 (max. 40 °C)
--------------------------	---

## Elementary relay



WAGO elementary relay	788-178
-----------------------	---------

## Commercial data

Product Group	6 (Interface Electronics)
Country of origin	CN
GTIN	4055143192347
Customs Tariff No.	85364900990

## Одобрения / Сертификати













### Ship Approvals

















Лого	Одобрение	Допълнителен текст за одобрение	Име на сертификат
	<b>DNV GL</b> Det Norske Veritas, Germanischer Lloyd	-	TAA00001D1
	<b>NK</b> Nippon Kaiji Kyokai	-	TA17255M
	<b>PRS</b> Polski Rejestr Statków	-	TE/2186 /880590/18

### UL-Approvals

Лого	Одобрение	Допълнителен текст за одобрение	Име на сертификат
	<b>UL</b> UL International Netherlands B.V. (ORDINARY LOCATIONS)	UL 508	E175199 Sec.6

## Съвместими продукти

ferrule		
	<b>Артикул №: 216-241</b> Ferrule; Sleeve for 0.5 mm <sup>2</sup> / 20 AWG; insulated; electro-tin plated; electrolytic copper; gastight crimped; acc. to DIN 46228, Part 4/09.90; white	<a href="http://www.wago.com/216-241">www.wago.com/216-241</a>
	<b>Артикул №: 216-242</b> Ferrule; Sleeve for 0.75 mm <sup>2</sup> / 18 AWG; insulated; electro-tin plated; electrolytic copper; gastight crimped; acc. to DIN 46228, Part 4/09.90; gray	<a href="http://www.wago.com/216-242">www.wago.com/216-242</a>
	<b>Артикул №: 216-243</b> Ferrule; Sleeve for 1 mm <sup>2</sup> / AWG 18; insulated; electro-tin plated; electrolytic copper; gastight crimped; acc. to DIN 46228, Part 4/09.90; red	<a href="http://www.wago.com/216-243">www.wago.com/216-243</a>
	<b>Артикул №: 216-244</b> Ferrule; Sleeve for 1.5 mm <sup>2</sup> / AWG 16; insulated; electro-tin plated; electrolytic copper; gastight crimped; acc. to DIN 46228, Part 4/09.90; black	<a href="http://www.wago.com/216-244">www.wago.com/216-244</a>
	<b>Артикул №: 216-542</b> Twin ferrule; Sleeve for 2 x 1 mm <sup>2</sup> / AWG 2 x 18; red, insulated; 12 mm long; red	<a href="http://www.wago.com/216-542">www.wago.com/216-542</a>
tools		
	<b>Артикул №: 210-720</b> Operating tool; Blade: 3.5 x 0.5 mm; with a partially insulated shaft	<a href="http://www.wago.com/210-720">www.wago.com/210-720</a>
Marking accessories		
	<b>Артикул №: 2009-110</b> Marking strips; on reel; not stretchable; plain; snap-on type; white	<a href="http://www.wago.com/2009-110">www.wago.com/2009-110</a>
	<b>Артикул №: 2009-115</b> WMB-Inline; for Smart Printer; on reel; stretchable 5 - 5.2 mm; plain; snap-on type; white	<a href="http://www.wago.com/2009-115">www.wago.com/2009-115</a>
	<b>Артикул №: 2009-115/000-002</b> WMB-Inline; for Smart Printer; on reel; stretchable 5 - 5.2 mm; plain; snap-on type; yellow	<a href="http://www.wago.com/2009-115/000-002">www.wago.com/2009-115/000-002</a>
	<b>Артикул №: 2009-115/000-006</b> WMB-Inline; for Smart Printer; on reel; stretchable 5 - 5.2 mm; plain; snap-on type; blue	<a href="http://www.wago.com/2009-115/000-006">www.wago.com/2009-115/000-006</a>
	<b>Артикул №: 2009-115/000-007</b> WMB-Inline; for Smart Printer; on reel; stretchable 5 - 5.2 mm; plain; snap-on type; gray	<a href="http://www.wago.com/2009-115/000-007">www.wago.com/2009-115/000-007</a>
	<b>Артикул №: 2009-115/000-012</b> WMB-Inline; for Smart Printer; on reel; stretchable 5 - 5.2 mm; plain; snap-on type; orange	<a href="http://www.wago.com/2009-115/000-012">www.wago.com/2009-115/000-012</a>
	<b>Артикул №: 2009-115/000-017</b> WMB-Inline; for Smart Printer; on reel; stretchable 5 - 5.2 mm; plain; snap-on type; light green	<a href="http://www.wago.com/2009-115/000-017">www.wago.com/2009-115/000-017</a>

	<b>Артикул №: 2009-115/000-023</b> WMB-Inline; for Smart Printer; on reel; stretchable 5 - 5.2 mm; plain; snap-on type; green	<a href="http://www.wago.com/2009-115/000-023">www.wago.com/2009-115/000-023</a>
	<b>Артикул №: 209-128</b> Adaptor	<a href="http://www.wago.com/209-128">www.wago.com/209-128</a>
	<b>Артикул №: 209-183</b> Marker card; white	<a href="http://www.wago.com/209-183">www.wago.com/209-183</a>
	<b>Артикул №: 210-110</b> Fiber-tip pen	<a href="http://www.wago.com/210-110">www.wago.com/210-110</a>
	<b>Артикул №: 793-501</b> WMB marking card; as card; not stretchable; plain; snap-on type; white	<a href="http://www.wago.com/793-501">www.wago.com/793-501</a>
	<b>Артикул №: 793-501/000-002</b> WMB marking card; as card; not stretchable; plain; snap-on type; white	<a href="http://www.wago.com/793-501/000-002">www.wago.com/793-501/000-002</a>
	<b>Артикул №: 793-501/000-005</b> WMB marking card; as card; not stretchable; plain; snap-on type; white	<a href="http://www.wago.com/793-501/000-005">www.wago.com/793-501/000-005</a>
	<b>Артикул №: 793-501/000-006</b> WMB marking card; as card; not stretchable; plain; snap-on type; white	<a href="http://www.wago.com/793-501/000-006">www.wago.com/793-501/000-006</a>
	<b>Артикул №: 793-501/000-007</b> WMB marking card; as card; not stretchable; plain; snap-on type; white	<a href="http://www.wago.com/793-501/000-007">www.wago.com/793-501/000-007</a>
	<b>Артикул №: 793-501/000-012</b> WMB marking card; as card; not stretchable; plain; snap-on type; white	<a href="http://www.wago.com/793-501/000-012">www.wago.com/793-501/000-012</a>
	<b>Артикул №: 793-501/000-017</b> WMB marking card; as card; not stretchable; plain; snap-on type; white	<a href="http://www.wago.com/793-501/000-017">www.wago.com/793-501/000-017</a>
	<b>Артикул №: 793-501/000-023</b> WMB marking card; as card; not stretchable; plain; snap-on type; white	<a href="http://www.wago.com/793-501/000-023">www.wago.com/793-501/000-023</a>
	<b>Артикул №: 793-501/000-024</b> WMB marking card; as card; not stretchable; plain; snap-on type; white	<a href="http://www.wago.com/793-501/000-024">www.wago.com/793-501/000-024</a>
	<b>Артикул №: 793-502</b> WMB marking card; as card; MARKED; 1 ... 10 (10x); not stretchable; Horizontal marking; snap-on type; white	<a href="http://www.wago.com/793-502">www.wago.com/793-502</a>
	<b>Артикул №: 793-502/000-002</b> WMB marking card; as card; MARKED; 1 ... 10 (10x); not stretchable; Horizontal marking; snap-on type; white	<a href="http://www.wago.com/793-502/000-002">www.wago.com/793-502/000-002</a>
	<b>Артикул №: 793-502/000-005</b> WMB marking card; as card; MARKED; 1 ... 10 (10x); not stretchable; Horizontal marking; snap-on type; white	<a href="http://www.wago.com/793-502/000-005">www.wago.com/793-502/000-005</a>

**Артикул №: 793-502/000-006**

WMB marking card; as card; MARKED; 1 ... 10 (10x); not stretchable; Horizontal marking; snap-on type; white

[www.wago.com/793-502/000-006](http://www.wago.com/793-502/000-006)**Артикул №: 793-502/000-007**

WMB marking card; as card; MARKED; 1 ... 10 (10x); not stretchable; Horizontal marking; snap-on type; white

[www.wago.com/793-502/000-007](http://www.wago.com/793-502/000-007)**Артикул №: 793-502/000-012**

WMB marking card; as card; MARKED; 1 ... 10 (10x); not stretchable; Horizontal marking; snap-on type; white

[www.wago.com/793-502/000-012](http://www.wago.com/793-502/000-012)**Артикул №: 793-502/000-017**

WMB marking card; as card; MARKED; 1 ... 10 (10x); not stretchable; Horizontal marking; snap-on type; white

[www.wago.com/793-502/000-017](http://www.wago.com/793-502/000-017)**Артикул №: 793-502/000-023**

WMB marking card; as card; MARKED; 1 ... 10 (10x); not stretchable; Horizontal marking; snap-on type; white

[www.wago.com/793-502/000-023](http://www.wago.com/793-502/000-023)**Артикул №: 793-502/000-024**

WMB marking card; as card; MARKED; 1 ... 10 (10x); not stretchable; Horizontal marking; snap-on type; white

[www.wago.com/793-502/000-024](http://www.wago.com/793-502/000-024)**Артикул №: 793-503**

WMB marking card; as card; MARKED; 11 ... 20 (10x); not stretchable; Horizontal marking; snap-on type; white

[www.wago.com/793-503](http://www.wago.com/793-503)**Артикул №: 793-503/000-002**

WMB marking card; as card; MARKED; 11 ... 20 (10x); not stretchable; Horizontal marking; snap-on type; white

[www.wago.com/793-503/000-002](http://www.wago.com/793-503/000-002)**Артикул №: 793-503/000-005**

WMB marking card; as card; MARKED; 11 ... 20 (10x); not stretchable; Horizontal marking; snap-on type; white

[www.wago.com/793-503/000-005](http://www.wago.com/793-503/000-005)**Артикул №: 793-503/000-006**

WMB marking card; as card; MARKED; 11 ... 20 (10x); not stretchable; Horizontal marking; snap-on type; white

[www.wago.com/793-503/000-006](http://www.wago.com/793-503/000-006)**Артикул №: 793-503/000-007**

WMB marking card; as card; MARKED; 11 ... 20 (10x); not stretchable; Horizontal marking; snap-on type; white

[www.wago.com/793-503/000-007](http://www.wago.com/793-503/000-007)**Артикул №: 793-503/000-012**

WMB marking card; as card; MARKED; 11 ... 20 (10x); not stretchable; Horizontal marking; snap-on type; white

[www.wago.com/793-503/000-012](http://www.wago.com/793-503/000-012)**Артикул №: 793-503/000-017**

WMB marking card; as card; MARKED; 11 ... 20 (10x); not stretchable; Horizontal marking; snap-on type; white















[www.wago.com/793-503/000-017](http://www.wago.com/793-503/000-017)**Артикул №: 793-503/000-023**

WMB marking card; as card; MARKED; 11 ... 20 (10x); not stretchable; Horizontal marking; snap-on type; white

[www.wago.com/793-503/000-023](http://www.wago.com/793-503/000-023)**Артикул №: 793-503/000-024**

WMB marking card; as card; MARKED; 11 ... 20 (10x); not stretchable; Horizontal marking; snap-on type; white

[www.wago.com/793-503/000-024](http://www.wago.com/793-503/000-024)

	<b>Артикул №: 793-504</b> WMB marking card; as card; MARKED; 21 ... 30 (10x); not stretchable; Horizontal marking; snap-on type; <a href="http://www.wago.com/793-504">www.wago.com/793-504</a> white
	<b>Артикул №: 793-504/000-002</b> WMB marking card; as card; MARKED; 21 ... 30 (10x); not stretchable; Horizontal marking; snap-on type; <a href="http://www.wago.com/793-504/000-002">www.wago.com/793-504/000-002</a> white
	<b>Артикул №: 793-504/000-005</b> WMB marking card; as card; MARKED; 21 ... 30 (10x); not stretchable; Horizontal marking; snap-on type; <a href="http://www.wago.com/793-504/000-005">www.wago.com/793-504/000-005</a> white
	<b>Артикул №: 793-504/000-006</b> WMB marking card; as card; MARKED; 21 ... 30 (10x); not stretchable; Horizontal marking; snap-on type; <a href="http://www.wago.com/793-504/000-006">www.wago.com/793-504/000-006</a> white
	<b>Артикул №: 793-504/000-012</b> WMB marking card; as card; MARKED; 21 ... 30 (10x); not stretchable; Horizontal marking; snap-on type; <a href="http://www.wago.com/793-504/000-012">www.wago.com/793-504/000-012</a> white
	<b>Артикул №: 793-504/000-017</b> WMB marking card; as card; MARKED; 21 ... 30 (10x); not stretchable; Horizontal marking; snap-on type; <a href="http://www.wago.com/793-504/000-017">www.wago.com/793-504/000-017</a> white
	<b>Артикул №: 793-504/000-023</b> WMB marking card; as card; MARKED; 21 ... 30 (10x); not stretchable; Horizontal marking; snap-on type; <a href="http://www.wago.com/793-504/000-023">www.wago.com/793-504/000-023</a> white
	<b>Артикул №: 793-505</b> WMB marking card; as card; MARKED; 31 ... 40 (10x); not stretchable; Horizontal marking; snap-on type; <a href="http://www.wago.com/793-505">www.wago.com/793-505</a> white
	<b>Артикул №: 793-505/000-005</b> WMB marking card; as card; MARKED; 31 ... 40 (10x); not stretchable; Horizontal marking; snap-on type; <a href="http://www.wago.com/793-505/000-005">www.wago.com/793-505/000-005</a> white
	<b>Артикул №: 793-505/000-006</b> WMB marking card; as card; MARKED; 31 ... 40 (10x); not stretchable; Horizontal marking; snap-on type; <a href="http://www.wago.com/793-505/000-006">www.wago.com/793-505/000-006</a> white
	<b>Артикул №: 793-505/000-007</b> WMB marking card; as card; MARKED; 31 ... 40 (10x); not stretchable; Horizontal marking; snap-on type; <a href="http://www.wago.com/793-505/000-007">www.wago.com/793-505/000-007</a> white
	<b>Артикул №: 793-505/000-012</b> WMB marking card; as card; MARKED; 31 ... 40 (10x); not stretchable; Horizontal marking; snap-on type; <a href="http://www.wago.com/793-505/000-012">www.wago.com/793-505/000-012</a> white
	<b>Артикул №: 793-506</b> WMB marking card; as card; MARKED; 41 ... 50 (10x); not stretchable; Horizontal marking; snap-on type; <a href="http://www.wago.com/793-506">www.wago.com/793-506</a> white
	<b>Артикул №: 793-506/000-005</b> WMB marking card; as card; MARKED; 41 ... 50 (10x); not stretchable; Horizontal marking; snap-on type; <a href="http://www.wago.com/793-506/000-005">www.wago.com/793-506/000-005</a> white
	<b>Артикул №: 793-506/000-006</b> WMB marking card; as card; MARKED; 41 ... 50 (10x); not stretchable; Horizontal marking; snap-on type; <a href="http://www.wago.com/793-506/000-006">www.wago.com/793-506/000-006</a> white

**Артикул №: 793-506/000-012**

WMB marking card; as card; MARKED; 41 ... 50 (10x); not stretchable; Horizontal marking; snap-on type; white

[www.wago.com/793-506/000-012](http://www.wago.com/793-506/000-012)**Артикул №: 793-506/000-017**

WMB marking card; as card; MARKED; 41 ... 50 (10x); not stretchable; Horizontal marking; snap-on type; white

[www.wago.com/793-506/000-017](http://www.wago.com/793-506/000-017)**Артикул №: 793-5501**

WMB marking card; as card; for terminal block width 5 - 17.5 mm; stretchable 5 - 5.2 mm; plain; snap-on type; white

[www.wago.com/793-5501](http://www.wago.com/793-5501)**Артикул №: 793-5501/000-002**

WMB marking card; as card; for terminal block width 5 - 17.5 mm; stretchable 5 - 5.2 mm; plain; snap-on type; yellow

[www.wago.com/793-5501/000-002](http://www.wago.com/793-5501/000-002)**Артикул №: 793-5501/000-005**

WMB marking card; as card; stretchable 5 - 5.2 mm; plain; snap-on type; red

[www.wago.com/793-5501/000-005](http://www.wago.com/793-5501/000-005)**Артикул №: 793-5501/000-006**

WMB marking card; as card; stretchable 5 - 5.2 mm; plain; snap-on type; blue

[www.wago.com/793-5501/000-006](http://www.wago.com/793-5501/000-006)**Артикул №: 793-5501/000-007**

WMB marking card; as card; stretchable 5 - 5.2 mm; plain; snap-on type; gray

[www.wago.com/793-5501/000-007](http://www.wago.com/793-5501/000-007)**Артикул №: 793-5501/000-012**

WMB marking card; as card; stretchable 5 - 5.2 mm; plain; snap-on type; orange

[www.wago.com/793-5501/000-012](http://www.wago.com/793-5501/000-012)**Артикул №: 793-5501/000-014**

WMB marking card; as card; stretchable 5 - 5.2 mm; plain; snap-on type; brown

[www.wago.com/793-5501/000-014](http://www.wago.com/793-5501/000-014)**Артикул №: 793-5501/000-017**

WMB marking card; as card; stretchable 5 - 5.2 mm; plain; snap-on type; light green

[www.wago.com/793-5501/000-017](http://www.wago.com/793-5501/000-017)**Артикул №: 793-5501/000-023**

WMB marking card; as card; stretchable 5 - 5.2 mm; plain; snap-on type; green

[www.wago.com/793-5501/000-023](http://www.wago.com/793-5501/000-023)**Артикул №: 793-5501/000-024**

WMB marking card; as card; stretchable 5 - 5.2 mm; plain; snap-on type; violet

[www.wago.com/793-5501/000-024](http://www.wago.com/793-5501/000-024)**Артикул №: 793-566**

WMB marking card; as card; MARKED; 1 ... 50 (2x); not stretchable; Horizontal marking; snap-on type; white

[www.wago.com/793-566](http://www.wago.com/793-566)**Артикул №: 793-566/000-002**

WMB marking card; as card; MARKED; 1 ... 50 (2x); not stretchable; Horizontal marking; snap-on type; white

[www.wago.com/793-566/000-002](http://www.wago.com/793-566/000-002)**Артикул №: 793-566/000-005**

WMB marking card; as card; MARKED; 1 ... 50 (2x); not stretchable; Horizontal marking; snap-on type; white

[www.wago.com/793-566/000-005](http://www.wago.com/793-566/000-005)

**Артикул №: 793-566/000-006**

WMB marking card; as card; MARKED; 1 ... 50 (2x); not stretchable; Horizontal marking; snap-on type; white

[www.wago.com/793-566/000-006](http://www.wago.com/793-566/000-006)**Артикул №: 793-566/000-007**

WMB marking card; as card; MARKED; 1 ... 50 (2x); not stretchable; Horizontal marking; snap-on type; white

[www.wago.com/793-566/000-007](http://www.wago.com/793-566/000-007)**Артикул №: 793-566/000-012**

WMB marking card; as card; MARKED; 1 ... 50 (2x); not stretchable; Horizontal marking; snap-on type; white

[www.wago.com/793-566/000-012](http://www.wago.com/793-566/000-012)**Артикул №: 793-566/000-017**

WMB marking card; as card; MARKED; 1 ... 50 (2x); not stretchable; Horizontal marking; snap-on type; white

[www.wago.com/793-566/000-017](http://www.wago.com/793-566/000-017)**Артикул №: 793-566/000-023**

WMB marking card; as card; MARKED; 1 ... 50 (2x); not stretchable; Horizontal marking; snap-on type; white

[www.wago.com/793-566/000-023](http://www.wago.com/793-566/000-023)**Артикул №: 793-566/000-024**

WMB marking card; as card; MARKED; 1 ... 50 (2x); not stretchable; Horizontal marking; snap-on type; white

[www.wago.com/793-566/000-024](http://www.wago.com/793-566/000-024)**Jumper****Артикул №: 788-113**

Comb-style jumper bar; 2-way; insulated

[www.wago.com/788-113](http://www.wago.com/788-113)**Артикул №: 788-114**

Comb-style jumper bar; 3-way; insulated

[www.wago.com/788-114](http://www.wago.com/788-114)**Артикул №: 788-115**

Comb-style jumper bar; 4-way; insulated

[www.wago.com/788-115](http://www.wago.com/788-115)**Артикул №: 788-116**

Comb-style jumper bar; 6-way; insulated

[www.wago.com/788-116](http://www.wago.com/788-116)**Артикул №: 788-117**

Comb-style jumper bar; 8-way; insulated

[www.wago.com/788-117](http://www.wago.com/788-117)**Артикул №: 788-118**

Comb-style jumper bar; 2-way (1-3); insulated

[www.wago.com/788-118](http://www.wago.com/788-118)**Артикул №: 859-402**

Push-in type jumper bar; 2-way; Nominal current 18 A; insulated; light gray

[www.wago.com/859-402](http://www.wago.com/859-402)**Артикул №: 859-402/000-005**

Push-in type jumper bar; 2-way; Nominal current 18 A; insulated; red

[www.wago.com/859-402/000-005](http://www.wago.com/859-402/000-005)**Артикул №: 859-402/000-006**

Push-in type jumper bar; 2-way; Nominal current 18 A; insulated; blue

[www.wago.com/859-402/000-006](http://www.wago.com/859-402/000-006)**Артикул №: 859-402/000-029**

Push-in type jumper bar; 2-way; Nominal current 18 A; insulated; yellow

[www.wago.com/859-402/000-029](http://www.wago.com/859-402/000-029)**General accessories**



<b>Артикул №: 209-145</b> Group marker carrier	<a href="http://www.wago.com/209-145">www.wago.com/209-145</a>
<b>Артикул №: 209-184</b> Protection cover; transparent	<a href="http://www.wago.com/209-184">www.wago.com/209-184</a>
<b>Артикул №: 249-105</b> Group marker carrier	<a href="http://www.wago.com/249-105">www.wago.com/249-105</a>
<b>Артикул №: 788-125</b> Accessories for relay modules; Operation status indicator: red	<a href="http://www.wago.com/788-125">www.wago.com/788-125</a>
<b>Артикул №: 788-148</b> Filter module; RC filter element; Nominal voltage: 230 VAC	<a href="http://www.wago.com/788-148">www.wago.com/788-148</a>
<b>Артикул №: 788-178</b> Basic relay; Nominal input voltage: 230 VAC; 1 changeover contact; Limiting continuous current: 16 A; Module width: 13 mm; Module height: 15 mm	<a href="http://www.wago.com/788-178">www.wago.com/788-178</a>

## Изтегляния

### Documentation

#### Instruction Leaflet

Sockets with Elementary Relay/ SSR	V 1.0.0	pdf 2,4 MB	Изтегляне
------------------------------------	---------	---------------	-----------

#### Additional Information

Disposal; Electrical and electronic equipment, Packaging	V 1.0.0	pdf 265,8 kB	Изтегляне
--	---------	-----------------	-----------

### CAD/CAE-Data

#### CAD data

3D Download 788-508	URL	Изтегляне
---------------------	-----	-----------

#### EPLAN

EPLAN Data Portal 788-508	Изтегляне
---------------------------	-----------

#### WSCAD

WSCAD Universe 788-508	Изтегляне
------------------------	-----------



Подлежащи на промяна.

---

WAGO Kontakttechnik GmbH & Co. KG

Hansastr. 27

32423 Minden

Phone: +49571 887-0 | Fax: +49571 887-169

Email: [info.de@wago.com](mailto:info.de@wago.com) | Web: [www.wago.com](http://www.wago.com)

Имате ли въпроси относно нашите продукти?

Винаги ще се радваме да получим вашето обаждане на +359 2 489 46 09.